

The all-new Mercedes-Benz GLS. All kinds of strength.



Mercedes-Benz



The pinnacle of space and comfort is only to be found in the new GLS.

The new GLS does full justice to the “S” in its name. Like no other car in the world, it combines the effortless agility of an SUV with the inner qualities of an S-Class. Climb aboard and discover exquisite luxury, tangible comfort and an unprecedented standard of exemplary safety.



A rear compartment like none before.

The Mercedes-Benz GLS boasts of spacious, yet stylish interiors. It comes with 7 luxurious seats, complete with a world-class infotainment system and electrically adjustable second row seating. The Mercedes-Benz GLS can transform from a 7-seater to a Star with a spacious luggage compartment, effortlessly.

The world's most masterfully refined suspension.

When the going gets tough, the new GLS always retains its poise and composure like no other in its class, with the AIRMATIC suspension. The powerful 6 cylinder in-line engines boast of an unsurpassed level of refinement to give final touch to the car's unparalleled comfort.





Something special. On every trip, from any angle. With the Fit & Healthy features.

Not just a means of arrival at your destination, the new GLS is a thoughtful companion through your journey. The Fit & Healthy features understand, motivate and guide to keep you in the prime of your health while driving. Get ready to elevate your driving experience with a car that cares.

[64 color Ambient Lighting](#) | [4-Way Lumbar Support](#) | [Memory Package](#) | [Cruise Control](#) | [ENERGIZING seat kinetics](#) | [Vario Rear Seats](#) | [AIRMATIC Suspension with ADS+](#) | [Rear Comfort Package Plus](#) | [Chauffeur Package](#) | [Removable MBUX rear Tablet](#) | [5-zone THERMOTRONIC Automatic Climate Control](#) | [Burmester® surround sound system](#)

A wide-angle, high-angle shot of the interior of a Mercedes-Benz GLS. The view is from the driver's perspective, looking towards the front passenger seat. The dashboard is a wide, horizontal strip with a large central infotainment screen. The steering wheel is black with silver accents and the Mercedes-Benz logo. The interior is finished with dark leather and light-colored wood trim. The lighting is warm and ambient, highlighting the textures of the materials.

Climb aboard and revel in modern luxury.

In the new GLS everything you see and touch adds up to a first-class experience. The fluid transitions, the stylish wood trim and the all-digital Widescreen Cockpit blend harmoniously into the superlative interior. To top it all, the new GLS also features the MBUX infotainment system that understands you better than ever before.

Mercedes me

The all-new Mercedes me app. With a redesigned user interface, simpler navigation and enhanced features.

Geo-fencing

Set a perimeter for the car movement and receive notifications in case of vehicle movement beyond the parameter. Hence the feature enables easy monitoring when vehicle is being driven by others.

Windows/sunroof open close from App

Open / Close the windows and sunroof of your Mercedes-Benz remotely through the app. This enables better ventilation before you get into the car.

Vehicle Finder (enables horn and light flashing)

Find your vehicle in large parking lots with ease. Simply blow the horn or flash the headlamps through the app to locate your vehicle

Mercedes me Service app: Your digital assistant

Keep a tab on your Star's maintenance with ease. Get timely maintenance and service reminders. Book a service appointment and search dealerships with a single touch. What's more, access expert tips to keep your Star in its best shape with car care videos.

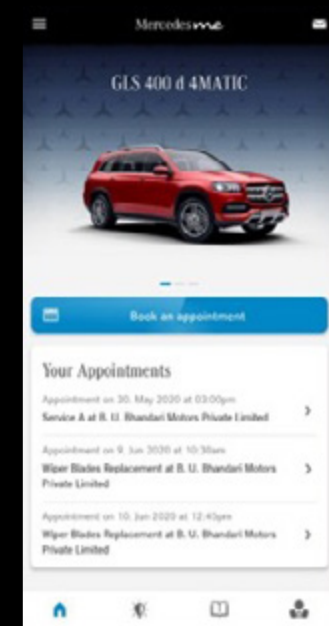
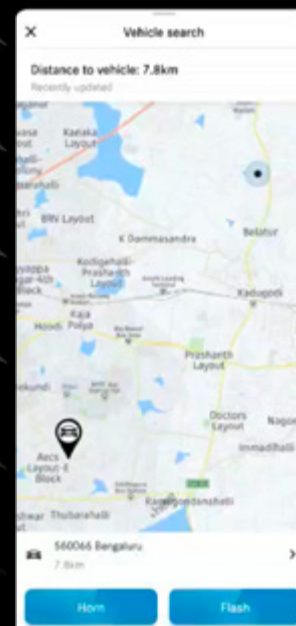
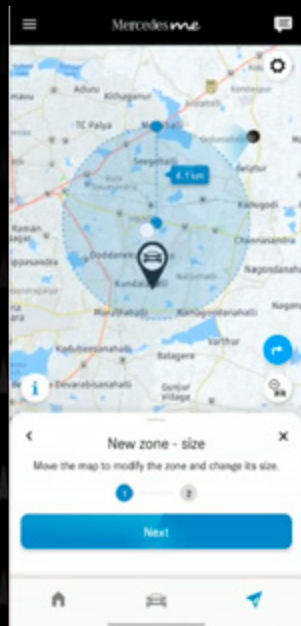

Mercedes me

Mercedes me connect allows drivers to stay in touch with their vehicles from anywhere in the world, and to obtain assistance at the touch of a button.

Vehicle Monitoring

Parked Vehicle Locator: It can locate your parked vehicle within a radius of 1.5 kilometres and show you on a map how to make your way back to the vehicle.

Vehicle Tracker: Your vehicle's geo-coordinates are sent by GPS.

Notification if the vehicle exceeds the set speed: Receive an alert if your vehicle exceeds a certain speed.

Vehicle Set-Up

Remote Retrieval of Vehicle Status: Information on Mercedes me App or the Mercedes me Portal.

Remote Door Locking and Unlocking: You can conveniently remotely lock or unlock your vehicle from the Mercedes me App.

Speed Alert: Receive an alert if your vehicle exceeds a certain speed.

Send2Car function: Send your address to your vehicle via an app.

Navigation Connectivity package

In combination with the standard-fit communication module (LTE) and the hard-disc navigation makes sure that you always reach your destination as quickly as possible by the best route.

Mercedes-Benz emergency call system

The Mercedes-Benz emergency call system can save you vital minutes in an emergency. If an accident is detected, a communications module with its own SIM card automatically triggers an emergency call which can shorten the time until the rescue services arrive.



Hey Mercedes

MBUX features in the all-new GLS

Display styles

You can customise the design and the entire look and feel of the Widescreen Cockpit. There is a choice of four display styles: "Classic", "Sport", "Progressive" and "Subtle". The chosen style tangibly characterises the interior atmosphere, especially in conjunction with the available ambient lighting.



MBUX Interior Assistant

Enjoy contactless ease of operation: this innovative system detects and interprets your hand and arm movements. As such you can activate selected functions in a matter of seconds. As part of this the system is able to differentiate between driver and front passenger – so that you can reach precisely the menus you wish to use.



Natural voice control

"Hey Mercedes." These two initial words start the natural, intuitive LINGUATRONIC voice control system which comes as standard. It reacts to almost every word. The system can even process indirect speech – the air conditioning will respond, e.g. to "I feel cold" and increase the temperature setting. At the same time the voice control also has learning capability. It attunes itself to your voice and thus understands you better.



Touch control concept

MBUX offers users maximum freedom for controlling all functions in the way most comfortable and convenient to them. Whether using voice control or intuitive touch functions. The new GLS comes with the option of a multimedia touch display. There is also a touchpad integrated in the centre console, which responds to single and multi-finger gestures as well as handwriting. Furthermore, the displays can be controlled using Touch Control buttons on the steering wheel.



Variants for the new Mercedes-Benz GLS: GLS 400d 4MATIC | GLS 450 4MATIC



Diesel Engine - GLS 400d 4MATIC

The most powerful diesel engine in the history of Mercedes-Benz bundles together state-of-the-art technology components. The engine sets standards in terms of agility and consumption. More than an additional bonus, the 6-cylinder in-line engine boasts an unsurpassed level of refinement. Variable valve lift (CAMTRONIC) on the exhaust side, makes emission control even more efficient and means the engine is an environmental diesel. NANOSLIDE® together with cylinder barrels as used by Mercedes-Benz in Formula 1, provides ideal lubrication, reduced friction and very high wear resistance owing to extremely hard cylinder contact faces with minuscule pores for oil absorption.

Petrol Engine - GLS 450 4MATIC

Systematically electrified for an outstanding driving experience – the Integrated Starter-Alternator boosts and recovers energy, while the 48 V onboard electrical system supplies the power consumers and the auxiliary compressor provides torque from just above idle speed. More than a bonus: the smooth running of six cylinders in line. The Integrated Starter-Alternator (ISA) combines the starter and alternator in a powerful electric motor between engine and transmission, assisting the internal combustion engine with up to 16 kW/22 hp and 250 Nm of torque (boost function).



*Please read the disclaimer.

AIRMATIC Package

In the AIRMATIC Package, an adaptive damping system meets modern air suspension. The result: an intelligent comfort suspension which is able to adjust automatically to the driving conditions, speed and load. As a result you benefit from counterbalancing driving stability with first-class comfort both on good and bad roads.

The adaptive damping system responds sensitively to unevenness. It is adjusted separately for each wheel and forms the basis for comfortable, relaxed travel. The sophisticated sensor system of the all-round self-levelling enables automatic lowering at high speeds and also in the sporty DYNAMIC SELECT drive programs.

The lower center of gravity improves handling stability. It enhances driving dynamics and therefore your driving pleasure. It reduces wind resistance and therefore fuel consumption.

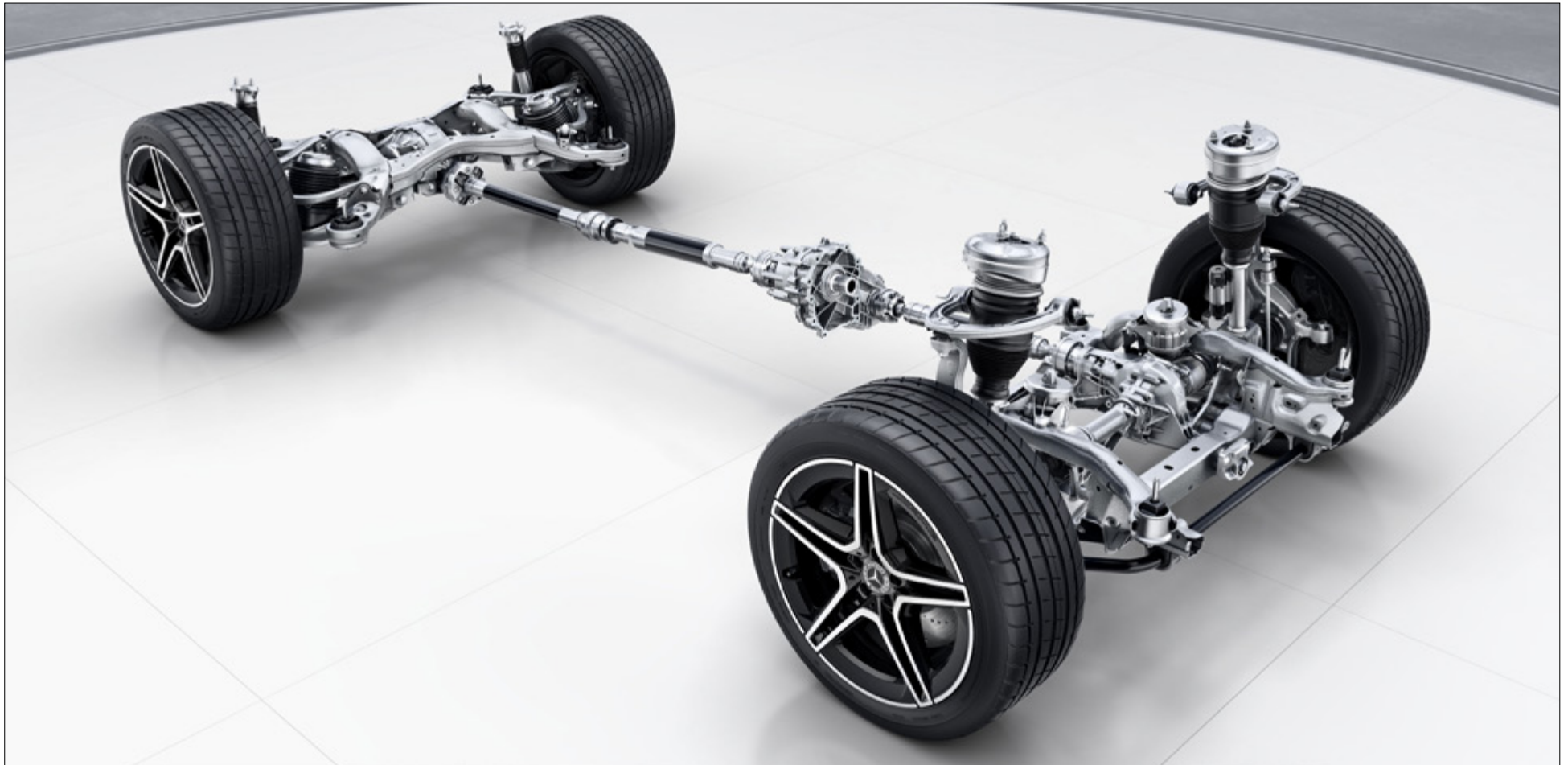

MULTIBEAM LED

For your perfect vision: the adaptive MULTIBEAM LED headlamps with individually controllable LEDs react to the traffic situation. Partial main beam omits other road users without dazzling them. When the road is clear, the ULTRA RANGE Highbeam increases the range upto 650 metres. The cornering light and active light functions also illuminate the field of vision to optimum effect.



Panoramic sliding roof

Whether open or closed, with the panoramic sliding sunroof you experience a wonderful feeling of freedom and enjoy a pleasantly bright ambience in the interior.

Whatever the roof's position, wind noise is effectively minimized. When the vehicle is parked, the panoramic sliding sunroof can also be opened and closed from outside – using the vehicle key with the functions "summer opening" and "comfort closing".

- Large glass module of tinted safety glass
- Net wind deflector in the front section
- Electric roller sunblind with one-touch control
- Comprehensive safety concept:
 - Obstruction sensor
 - Automatic rain closing function
 - PRE-SAFE® closing function



*Please read the disclaimer.

Underguard

This equipment protects the entire underbody of your vehicle. As such you are always perfectly equipped for those spontaneous off-road excursions. In addition, the underguard shields the engine compartment, thus effectively reducing dirt.

Aluminium-look, illuminated running boards with rubber studs

A real eye-catching feature are the illuminated, aluminium-finish running boards. They are mounted on the side at the height of the side skirts, thus making it easier for you to get into the front as well as the rear. Slip-resistant rubber studs ensure a firm foothold.



*Please read the disclaimer.

Mirror Package

The Mirror Package makes everyday driving easier: Electrically folding outside mirrors help protect your vehicle against annoying damage when parking. In addition, getting in and out of the vehicle in the dark is more convenient with the surround lighting. An attractive, eye-catching feature is the projection of the brand logo next to the opened side doors.



*Please read the disclaimer.

Burmester® surround sound system

Experience more performance and exclusivity with the legendary Burmester sound. The high-performance speakers develop a first-class surround sound. One can specifically optimize this for the front and rear seats to intensify the listening experience. A level of quality that is also visible, thanks to the high-quality Burmester lettering.

The basis for the impressive sound is provided by the 9-channel DSP amplifier, whose output power is perfectly matched to the speaker system. 13 high-performance speakers and a system output of 590 watts create an imposing sound field. Sophisticated noise compensation (VNC) adjusts music and sound dynamically to your driving conditions. With the fader and balance function, one can distribute the sound more to the front, rear or equally to all seats – or focus the listening experience in a seat row of your choice with the Sound Focus function.



*Please read the disclaimer.

Expression Interior

Adjust the colour scheme in your vehicle as the fancy takes you. With the ambient lighting system you have a choice of 64 colours, various colour schemes and effects at your disposal. Other highlights come courtesy of the elements in silver chrome plus the upholstery in ARTICO man-made leather. With the Ambiance package, the Mercedes-Benz design philosophy of Sensual Purity is brought to life – exclusive materials elegantly blend into the interior.

- Ambient lighting with 64 colours
- Comfort seats upholstered in ARTICO man-made leather
- Interior Chrome package:
 1. Controls and trim in the door panel area in silver chrome
 2. Controls on left next to the steering wheel in silver chrome
 3. Hand comforter, control switches and cup holders in the centre console in silver chrome
 4. Control bar for climate control in silver chrome



*Please read the disclaimer.

Widescreen cockpit

Inspirational design meets a fully digital display with flexible presentation options: the Widescreen Cockpit enables information to be truly experienced. The desired content can be positioned individually and the host of functions controlled intuitively thanks to touch technology.

Furthermore, you can select the display to suit your taste and give your cockpit an individual look. There is a choice of "Classic", "Sport", "Progressive" and "Subtle" display styles. You can also incorporate your desired style into the ambient lighting and select a suitable colour scheme.



5-Zone THERMOTRONIC Automatic Climate Control

The THERMOTRONIC automatic climate control system with 5-climate zones provides an individual feel-good climate on board. The driver and front passenger are able to set the temperature and air distribution to suit their personal needs. The climatic settings can be stored and retrieved at the touch of a button. Individually adjustable climate comfort for passengers in the third seat row is also available. This feature expands the THERMOTRONIC automatic climate control system to five zones. Temperature and ventilation intensity can be controlled separately for each of the five areas. As such all passengers are able to enjoy their desired feel-good climate.



Hard-Disc Navigation

Save time through fast hard disk navigation with flexible inputs via touch control or voice input. Here, 3D displays of points of interest, are also a visual delight. The intelligent system guides you reliably to your destination using both local as well as up-to-date online data.

The high-quality 2D or 3D map displays recommend the ideal lane for your next driving manoeuvre. The system will first determine the route you require. This can be the fastest way or, for example, a toll-free connection. You enter the data as you wish – on the touch screen, or using the touchpad, the Touch Control buttons or LINGUATRONIC. The system even understands you in colloquial language. Say "Hello Mercedes, take me to..." and indicate a desired location. And route guidance promptly starts, right away.

Another special feature is "what3words". This innovative coordinates system determines every single point on earth with exactly three words.



Smartphone Integration

Smartphone Integration connects the mobile phone with the multimedia system via Apple CarPlay™ and Android Auto™. This gives you convenient access to the most important applications of your smartphone. You can also use apps from third party service providers such as Spotify quickly and easily.

Because your concentration should continue to be devoted to your driving. This is why the voice control is more than just an appealing feature. You can submit your requests via the voice assistant in the car too.



Wireless Charging Front and Rear

Driving time becomes charging time – with just a simple hand movement your smartphone can be fixed in place in the oddments tray where it is charged wirelessly. Irrespective of the model and brand, compatible smartphones are charged wirelessly.

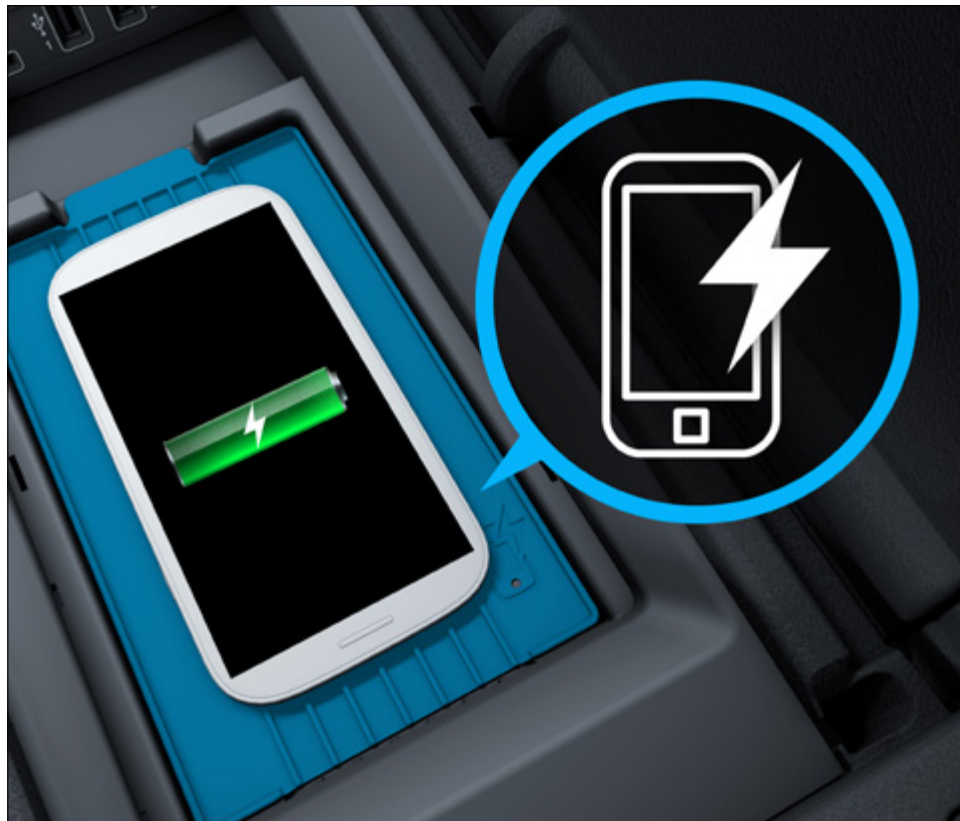

Memory Package Front

The Memory Package provides practical ease of operation – especially when your vehicle is used by different people. Besides seat adjustment, the individual position profiles also comprise the alignment of the steering column and exterior mirrors. After a change of driver or front passenger, your position can be restored at the press of a button.



*Please read the disclaimer.

Generous sense of space - 7 Seater Concept

The seats and cargo volume available in your vehicle are just as diverse as your lifestyle. The third seat row provides two full-fledged seats for taking extra passengers along. In addition it can be folded in and out electrically, so that you can also stow large items of luggage in no time at all.

- Seven seats in three seat rows
 - Second seat row as a bench seat with three seats
 - Third seat row with two full seats
 - If required, simultaneous electric folding of all seat backrests
 - i-Size child seat attachment points for safe attachment of i-Size or ISOFIX child seats
 - Backrests of the second seat row can be folded electrically in a ratio 40:20:40
- EASY-ENTRY entry aid
 - Fully power-adjustable second seat row with folding outer seat backrest
 - Control switches on the outer backrests of the second seat row and in the outer armrests of the third seat row



*Please read the disclaimer.

Rear Comfort Package Plus

With this package the second seat row becomes first class. Your passengers in the rear enjoy particularly comfortable travel thanks to comfort extras such as the extended centre armrest and centre console. Various stowage facilities are within easy reach as are connections and the removable MBUX rear tablet – for a unique information and communication experience in the rear.

- Widened luxury center armrest:
 - Removable MBUX rear tablet with 7-inch screen diagonal and camera function, docking station in high-gloss black for storage and charging, compatible with apps from the Google Play Store
 - Integral illuminated stowage compartment
 - 2 USB ports (5 V charging connection)
 - Wireless charging for mobile phones in the rear
- Extended center console:
 - 2 cup holders
 - charging system for mobile devices
- Luxury head restraints for the two outer rear seats:
 - elaborately padded auxiliary cushions
 - adjustable side bolsters
 - adjustable angle



*Please read the disclaimer.

Luxury rear head restraints

With the luxury head restraints your rear seat passengers enjoy first-class seating comfort on every trip. The strain is taken off the head and neck and they are supported thanks to the individually adjustable side bolsters. The high-quality upholstery helps to ensure a tangible sense of comfort and visible exclusivity.

Thanks to angle adjustment and an additional cushion, each passenger can find a comfortable head position. The ergonomically optimized side bolsters provide supple lateral support.



*Please read the disclaimer.

MBUX rear tablet

This multifunction touchscreen impresses in terms of functionality and design: passengers can enjoy direct access to the menu of the MBUX multimedia system and additionally control selected functions in the rear both conveniently and intuitively. The design of the tablet and docking station blends elegantly into the center armrest of the second seat row.

The MBUX rear tablet provides contemporary ease of operation and lends the interior a modern look. Touchscreen and docking station form a high-quality, ergonomic unit. The surface of the tablets is finished in bonded glass. The elegant docking station keeps the tablet secure when not in use or the battery needs to be charged.



*Please read the disclaimer.

Chauffeur Package

Seat on front passenger side electrically adjustable from the rear.



Electric sunblinds in rear doors

Seeing and not being seen: the electrically extending and retracting roller sunblinds in both rear doors protect passengers from prying eyes and against strong sunlight in summer. It is still possible to see through to the outside.

The roller sunblinds are made of film foil. This significantly reduces incoming sunlight and ensures that the interior does not heat up too much on warm days.



*Please read the disclaimer.

Pre-installation for entertainment and comfort features

First-class entertainment, in the second row too: the pre-installation allows you to easily connect a variety of equipment and accessory products. The system attaches to the backrests of the front seats and features an integral power supply – for undisturbed entertainment on longer journeys.



*Please read the disclaimer.

EASY-PACK tailgate

Extremely practical: the EASY-PACK tailgate can be opened and closed electrically and makes loading and unloading the boot even more convenient. You can start the opening and closing process very conveniently at the press of a button and interrupt it at any time by pressing the button again.



EASY-PACK load compartment cover

Protect your luggage from the sun and prying eyes: the EASY-PACK load compartment cover comprises of a retractable cover which is fitted behind the rear seats. You can remove this at any time and store it in the compartment provided beneath the load compartment floor.



USB-PACKAGE

Charge smartphone or tablet quickly – thanks to a total of eleven USB ports you can supply your mobile devices with power while on the road. In addition the ports enable devices to be connected to the vehicle and controlled.

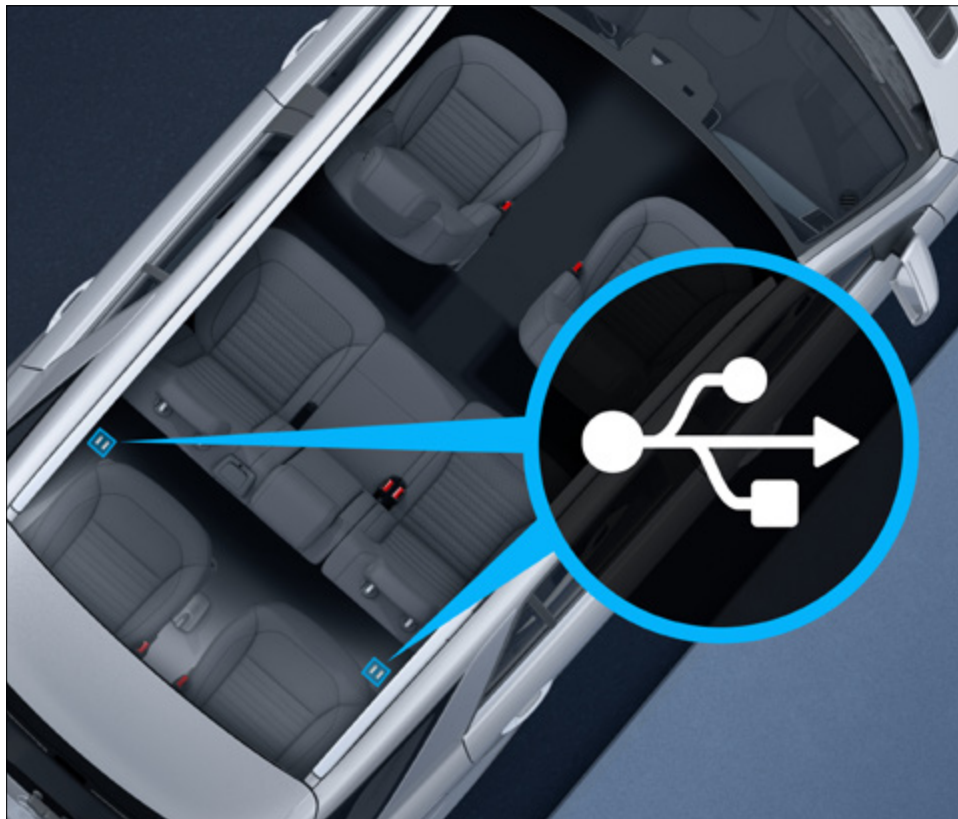

Velour floor mats

The velour floor mats additionally enhance your interior. They are finished in the respective appointments colour and edged. As such they blend into the interior design perfectly. In addition the mats protect the footwell against dirt – they can be removed easily to be vacuumed or cleaned.



Safety and Assistance

Adaptive Highbeam Assist Plus

Drive with permanent main beam. This virtually turns night into day and relieves the strain on you in your driving duties. See very far, don't dazzle – Adaptive Highbeam Assist Plus works according to this motto. The intelligent system spares oncoming traffic or vehicles in front with highly precise LEDs: you do not have to keep on changing over to low-beam headlamps.

- Automatic main-beam control for permanent broad illumination of the carriageway
- Active from a speed of 30 km/h on roads with no street lighting



*Please read the disclaimer.

Safety and Assistance

Airbags

The side airbags in the outer seat backrests can protect the chest and pelvis area of the driver and front passenger in a severe side impact. Together with the windowbags they boast optimum safety potential when it comes to reducing injuries. For this, the air cushions unfold between the door and the occupant.

- Airbags for driver and front passenger
- Sidebags for driver and front passenger
- Windowbags to protect the head area of the driver, front passenger and occupants in the outer rear seats
- Kneebag is able to protect the driver in the knee contact area of the dashboard
- Sidebag in Rear



*Please read the disclaimer.

Safety and Assistance

Active Brake Assist

Active Braking Assist can help you to avoid rear-end collisions and accidents with crossing pedestrians and cyclists. Besides distance and collision warning, it also provides situation- dependent brake boosting in the event that you apply the brakes with insufficient force. If you do not react, it is able to initiate autonomous emergency braking.

Active Braking Assist is designed to detect vehicles travelling in front and which are stationary, crossing pedestrians and cyclists in the danger zone in front of your vehicle. The functions are optimized for typical urban speeds. However, at higher speeds too the system is still always able react to slower moving vehicles.

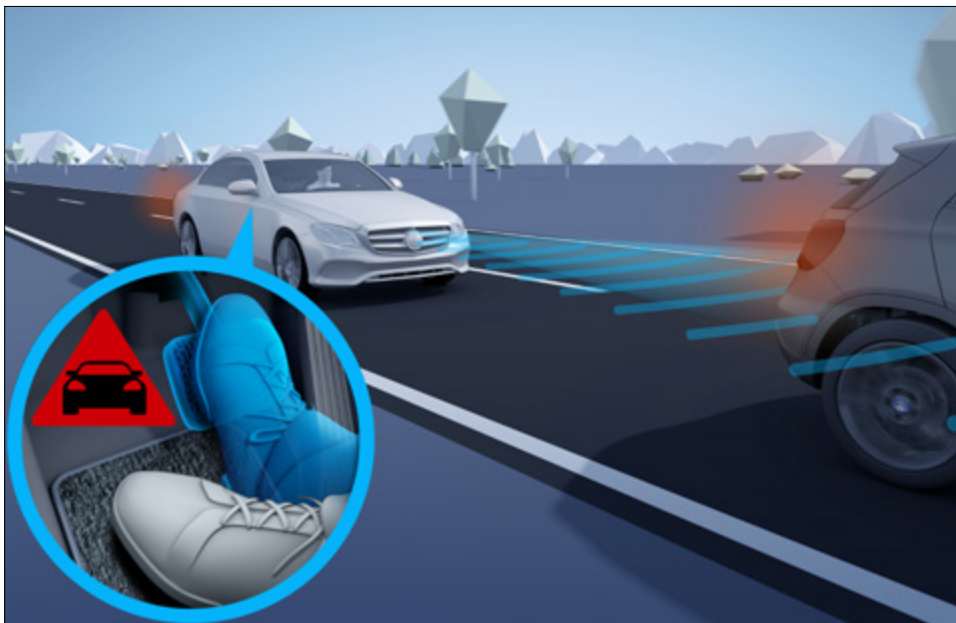

Blind Spot Assist

Blind Spot Assist takes a very close look for you – in particular as soon as you actuate the turn indicator. The system is thus able to give you a visual and audible warning of side collisions with other road users in the blind spot. After your trip, the system still remains alert and warns you if you open the door at the wrong time.



*Please read the disclaimer.

Safety and Assistance

Parking Package with 360-degree camera

Optimum parking service on board. Active Parking Assist with 360° camera makes it easier for you to find a parking space and to manoeuvre into and out of parking spaces. The choice is yours: thanks to all-round visibility you can park your vehicle yourself – or have your vehicle parked stress-free.



*Please read the disclaimer.

Genuine Accessories

Roof spoiler

Unflinchingly individual: a roof spoiler from Mercedes-Benz sets your vehicle apart. It gives the rear a more compact, powerful, accentuated look. Head-turning body styling and safe too: the roof spoiler does not affect the field of vision.



Load sill guard

The load sill guard in a chrome look reliably protects the boot sill of the vehicle against damage and signs of wear. A specially developed tape for the automotive exterior allows a quick and simple fitting. The load sill guard precisely adapts to the contours of the vehicle and, thanks to the carefully selected materials, ensures a high-class appeal.



Design side trim

Mercedes-Benz Sport Equipment side trim design with matt black finish. Lends the vehicle a more masculine effect and emphasizes the sporty and dynamic look. Simply secured in place using special adhesive tape. No paintwork and no entry in the vehicle documents required.



*Please read the disclaimer.

Genuine Accessories

Mercedes-Benz roof box

Available in different color variants to coordinate with your 8car's paintwork. Impact-resistant, sturdy, durable, recyclable, spray-protected. Gas-filled struts for easy opening and closing of lid. Straps to hold contents in place with maximum load capacity of 75 kg,unladen weight 20 kg.



Bicycle rack

The epitome of easy cycle transport: New Alustyle bicycle rack. Suitable for all cycle types, from road bikes to trekking bikes. Fully pre-assembled and ready to use.



Door handle recesses

An exclusive highlight: the refined, chrome-design door handle recesses lend the vehicle a polished, individual look. The stable, robust material is precision-tailored to the bodywork and protects the paintwork in the recess from scratches.



Genuine Accessories

Travel and Style Coat Hanger

The coat hanger – for crease-free clothes when you're on the move. It's easy to arrive looking smart: the sturdy coat hanger allows you to hang up items of clothing on board.



Folding table, Style & Travel Equipment

A practical place to put snacks and drinks during the journey. The folding table with direct adapter features a cup holder insert.



Coolbox

Whether you are taking cold drinks, a picnic or baby food with you, the multifunctional coolbox cools or warms according to your needs, making it the perfect accessory for any outing.



*Please read the disclaimer.

Upholstery

ARTICO man-made leather

Macchiato Beige

Black/Anthracite

Espresso Brown



Trim

High-gloss anthracite lime wood trim



*Please read the disclaimer.

Paintwork

NON-METALLIC

Polar White

METALLIC

Obsidian Black

Mojave Silver

Cavansite Blue

Selenite Grey

Hyacinth Red



*Please read the disclaimer.

Alloy

53.3 cm (21-inch) 5-triple-spoke light-alloy wheels painted in high-gloss Himalayas grey with a high-sheen finish, with 275/45 R 21 tyres (front) and 315/40 R 21 tyres (rear)



*Please read the disclaimer.

Dimensions

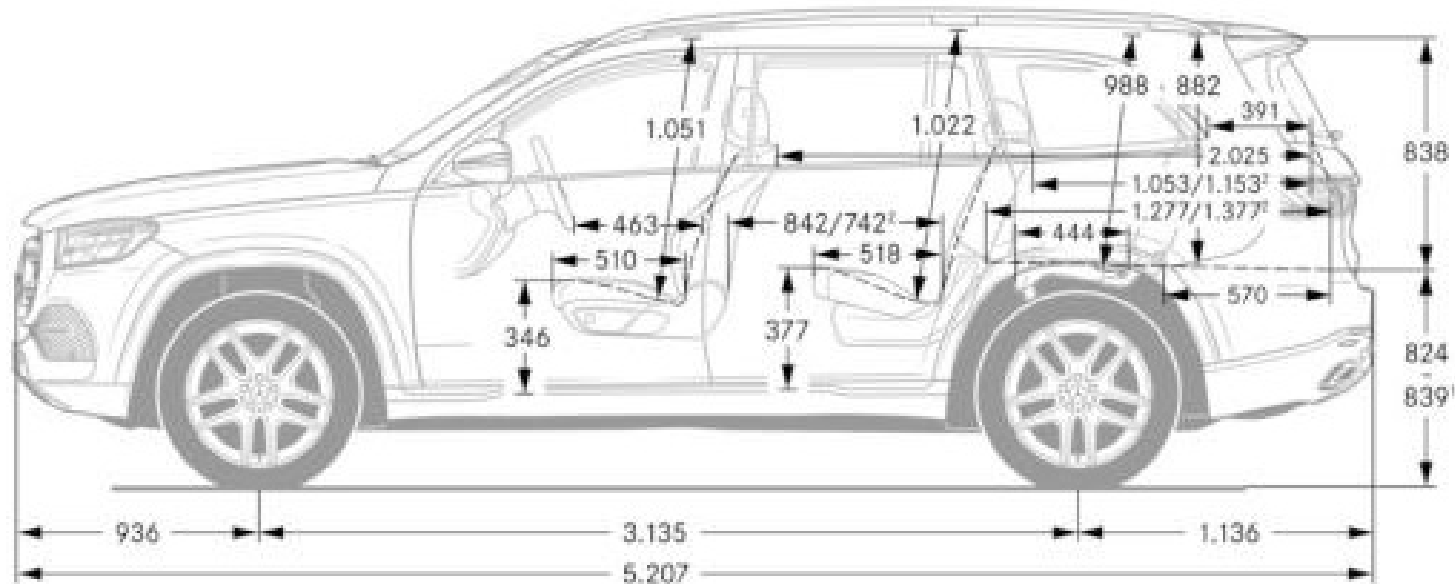
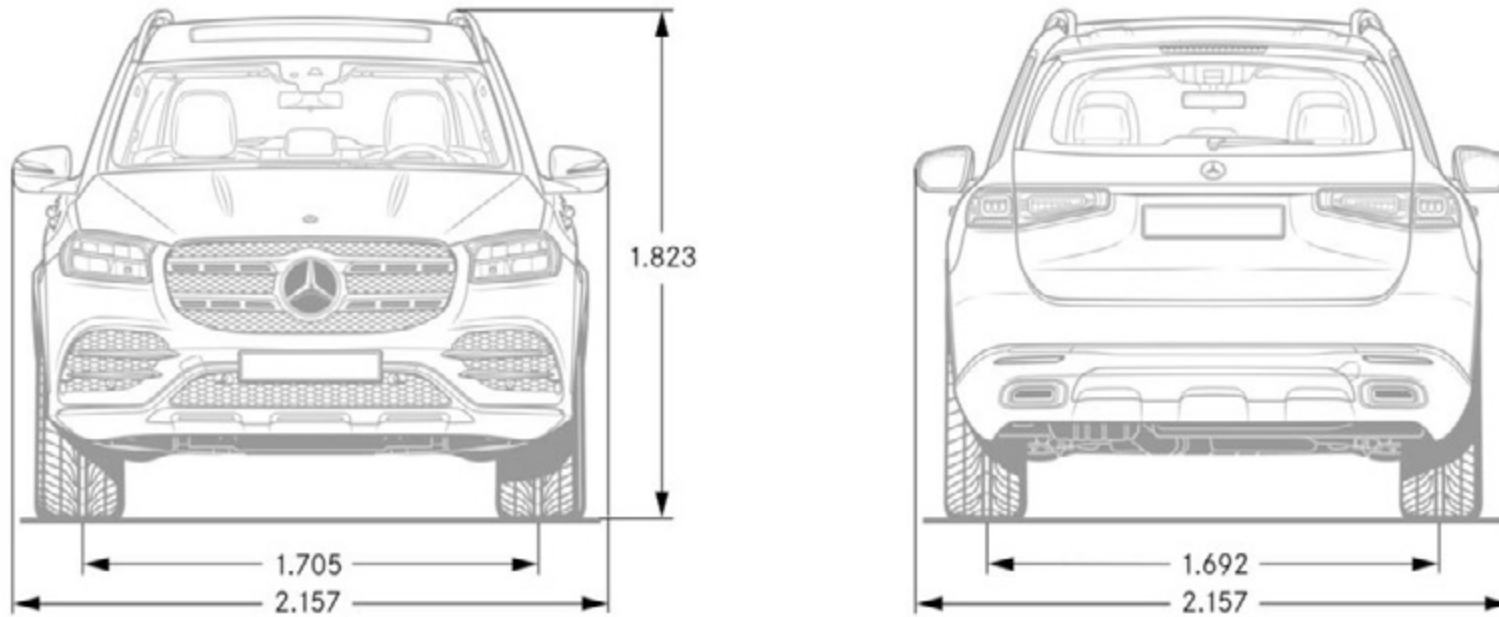

*Please read the disclaimer.

Technical Specification

	GLS 400d 4MATIC	GLS 450 4MATIC
Total displacement / No./arrangement of cylinders	2925 cc / L6	2999 cc / L6
Rated output in kW (hp) @ rpm	243 [330]/3600-4200	270 [367]/5500-6100
Rated torque (Nm @ rpm)	700/1200 - 3200	500/1600 - 4500
Transmission	9G-TRONIC automatic	9G-TRONIC automatic
Acceleration from 0 - 100 km / h (s)	6.3	6.2
Top speed (km/hr)	238	246
L x W x H (mm)	5207 x 2157 x 1823	5207 x 2157 x 1823
On-board Electrical system	14 V	48 V
Kerb Weight	2505	2460
Gross weight	3250	3230

My Mercedes. My Service.

You enjoy life. We'll take care of your Mercedes.

The best or nothing! This statement conveys how Mercedes-Benz aspires to develop and build highly desirable, top-class vehicles. The same passion, pledge and commitment apply to the Mercedes-Benz Service too. The bouquet of world-class After-Sales products will not only attend to every need of your Star but will also redefine the concept of ownership experience with a focus on providing end-to-end customer delight. After all, you Star deserves nothing less than the best.

STAR EASE

Delivering the best-in-class value

Servicing your Star does not get any better than this. With the STAR Ease Maintenance Packages, pay a defined cost of maintenance based on the model, contract period and mileage and say goodbye to spending on service every time. Plus, enjoy exclusive features like priority handling, shorter waiting time and quicker processes.

Advance Assurance Program

Extending your warranty coverage

With Advance Assurance Program, experience complete peace of mind. While this Extended Warranty Program kicks in the moment your standard 3 years warranty comes to an end, it can be extended further up to 6 years at a nominal price. Also, it comes with a bouquet of privileges for a worry-free time with your Star.

MOBILO

Providing you 24x7 mobility support

Your vehicle comes with Mobilo which provides round-the-clock on-road assistance service. Mobilo comes as a standard for 3 years and can be extended further up to 8 years at a nominal cost. This service offers privileges like vehicle towing facility, replacement vehicle, hotel accommodation, just to name a few.



My Mercedes. My Service.

Digital Service Drive

Ensuring convenience and transparency of service.

Servicing your Star is the last thing you will ever have to worry about. We provide transparent, convenient and hassle-free service. Our customer-friendly service features work around your busy schedule so that you have one less thing to focus upon.

Now booking your appointment is quick and easy.

To book your online service appointment, visit <http://mb4.me/SelectDealer>

Premier Express*

Because we value your time as much as you do.

Life gets busy and so we have designed Premier Express, our vehicle care service to help you get in and out quickly. While the visit will be brief, the service offered by our technicians will be comprehensive and complete. All to ensure your Mercedes-Benz is running for miles to come.

*Available at select locations only



My Mercedes. My Service.

Mercedes-Benz Genuine Parts Now with 2 years* of warranty

Mercedes-Benz Genuine Parts are crafted to the state-of-the-art standards of Mercedes-Benz, protecting your vehicle's performance while maintaining the style, comfort and safety, for the years to come. Also, they come with a warranty of up to 2 years, ensuring you a peaceful ownership experience with your Star.

* Terms & Conditions Apply



Mercedes-Benz Approved Tyres and Rims Ensuring every ride is a safe and joyful one

Maximise the safety and comfort of your Star with Mercedes-Benz approved tyres and rims. While the Mercedes-Benz approved tyres are designed to optimally match your car's performance, the Mercedes-Benz approved rims are designed to lend an exceptional style to the exterior of your Star and are also engineered for optimal performance.



Mercedes-Benz Genuine Chemical Products Because your Star deserves nothing but the original

Mercedes-Benz Genuine Chemical Products are specially tested for compatibility with the materials in our cars and meet the high quality standards. Also, our products have been approved under Daimler AG's strict, self-imposed environmental norms. Now with Mercedes-Benz Genuine Chemical Products, experience a whole new world of superior products that support throughout the car's life cycle.



*Please read the disclaimer.

[Test Drive](#)[Contact Us](#)[Dealer Locator](#)

Mercedes-Benz India Private Limited: E-3, MIDC Chakan - Phase III, Chakan Industrial Area, Kuruli & Nighoje, Tal: Khed, Pune - 410 501 (India)
Toll free No.: 0008000501888. e-mail: cs.ind@cac.mercedes-benz.com, **website:** www.mercedes-benz.co.in

Please note: This brochure is intended for general information, description and illustration of the Product including optional functions and equipment and may not be specific to a Product since specification of a product may change from time to time. Optional features, functions and equipment etc. may not be present in the Standard or Variant Product or Special Edition Product. Further, Standard specifications of a product may also vary from time to time. Colours may differ from those shown in pictures in the brochure, owing to printing. Mercedes-Benz India reserves the right to make changes, at any point of time, without prior notice, in design, colours, materials, components, equipment, specifications, features, functions, make and models etc. The information given in this brochure shall be regarded as accurate at the time of going to print and may vary thereafter due to any developments or any other reason. Interested parties should confirm with the Authorised Dealer about the correct specification of the product they desire to purchase. For the latest authentic information and updates, kindly contact your nearest Authorised Dealer.

All title, ownership rights and intellectual property rights in and relating to this brochure / magazine or publication material or any copies thereof including but not limited to copyright, logos, names, trademarks, service marks, design, text, images, links, concepts and themes are owned by Daimler AG and/or its subsidiaries collectively or used under authorised license by the Daimler AG. Any reproduction, transmission, publication, performance, broadcast, alteration, license, creation of derivative works or other use in whole or in part in any manner without the prior written consent of the Daimler AG is strictly prohibited.

Mercedes-Benz cars: The GLS meets Bharat Stage VI equivalent emission norms.

CIN - U34102PN1994PTC083160